

Magnetic Sensor ICs

Unipolar Detection High Performance Hall-Effect Sensor IC



AS1785

● General Description

Using BCD process, the AS1785 is designed for high performance unipolar detection hall-effect application, such as home appliances, rotor position sensing, brushless DC motor etc. The hall IC integrated an on-chip hall voltage generator for magnetic sensing, a comparator that amplifies the hall voltage, hall sensor with dynamic offset cancellation system, an pull-up resistance, and a Schmitt trigger to provide switching hysteresis for noise rejection, and a voltage regulator for operation with supply voltage of 2.8V to 28V.

AS1785 is designed to respond to **North poles**. While the magnetic flux density (B) is larger than operate point (B_{OP}), the output will be turned on (low), the output is held until the magnetic flux density (B) is lower than release point (B_{RP}), then turn off (high).

The device is available in SIP-3L and SOT23-3L Package and is rated over the -40°C to 150°C. the package is RoHS compliant.

● Features

- High Performance BCD Process Tech.
- Input Voltage Range : 2.8V to 28V
- Resistant to physical stress
- Unipolar Latch Operation
- High Sensitivity Hall Sensor
- High Chopping Frequency
- Magnetic Sensitivity (typical)
 $B_{OP}=-100\text{Gauss}$, $B_{RP}=-70\text{Gauss}$
- **Need Pull-up Resistance**
- Reverse Voltage Protection: **-24V**
- Small Solution Size
- RoHS Compliant
- SIP-3L and SOT23-3L Packages
- -40°C to +150 °C Temperature Range

● Applications

- Electric Tools
- Automotive, Home appliances, Industrial
- Rotor Position Sensing and Flow Meters
- Brushless DC Motor/Fan
- Speed Measurement
- Revolution Counting
- Valve and Solenoid Status
- Proximity Sensing
- Tachometers
- Magnetic Encoder

■ Ordering Information



Part Number	B_{OP}/B_{RP} (Gauss)	Package Type	Package Qty	Temperature	Eco Plan
AS1785MBY	-100/-70	SIP-3L	1K/Package	-40~125°C	RoHS
AS1785STRY	-100/-70	SOT23-3L	7-in reel 3000pcs/reel	-40~125°C	RoHS
AS1785MBZ	-100/-70	SIP-3L	1K/Package	-40~150°C	RoHS
AS1785STRZ	-100/-70	SOT23-3L	7-in reel 3000pcs/reel	-40~150°C	RoHS

■ **Marking Information**

SIP-3L

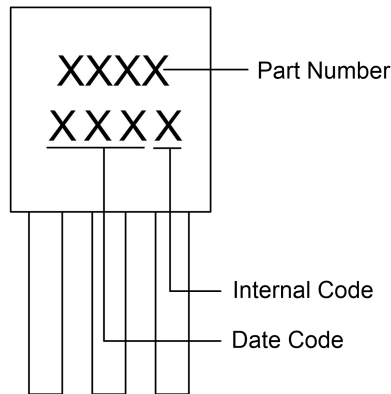

SOT23-3L

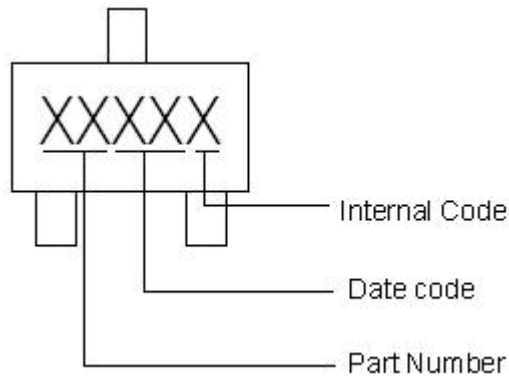

■ **Typical Application Circuit**

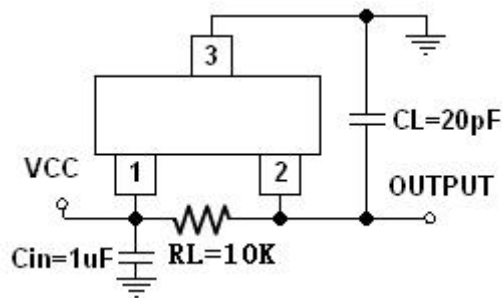
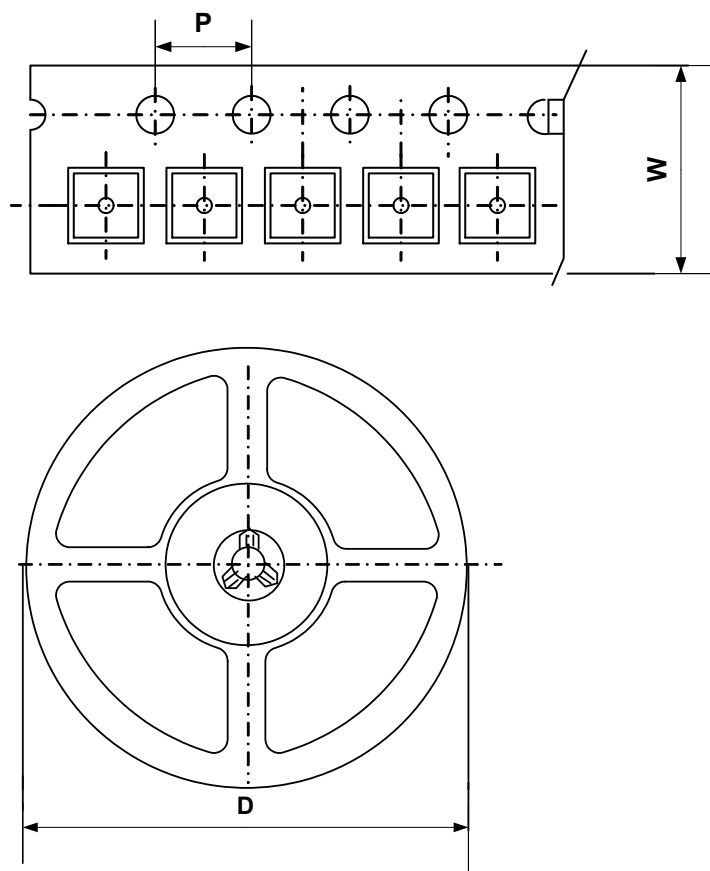

Figure 1, Typical Application Circuit of AS1785

■ **Packing Information**

SOT23-3L



Package Type	Carrier Width (W)	Pitch (P)	Reel Size(D)	Packing Minimum
SOT23-3L	8.0±0.1 mm	4.0±0.1 mm	180±1 mm	3000pcs

Note: Carrier Tape Dimension, Reel Size and Packing Minimum

■ **Packing Information**

1. Packing type: Bulk
2. Packing minimum: 1000pcs