

Magnetic Sensor IC

Omnipolar High Performance Hall-Effect Sensor IC



AS1877

● General Description

Using BiCMOS process, the AS1877 is designed for high performance Omnipolar detection hall-effect application, such as automotive, industrial, electric tools, home appliances, rotor position sensing, brushless DC motor etc. The hall IC integrated an on-chip hall voltage generator for magnetic sensing, a comparator that amplifiers the hall voltage, hall sensor with dynamic offset cancellation system, an pull-up resistance, and a Schmitt trigger to provide switching hysteresis for noise rejection, and a voltage regulator for operation with supply voltage of 2.5V to 40V.

AS1877 is designed to respond to alternating North and South poles. While the magnetic flux density (B) is larger than operate point (B_{OP}), the output will be turned on (low), the output is held until the magnetic flux density (B) is lower than release point (B_{RP}), then turn off (high).

The device is available in SIP-3L and SOT23-3L Package and is rated over the -40°C to 150°C. the package is RoHS compliant.

● Features

- High Performance BiCMOS Process Tech.
- Input Voltage Range : 2.5V to 40V
- Resistant to physical stress
- Omnipolar Operation
- High Sensitivity Hall Sensor
- High Chopping Frequency
- Magnetic Sensitivity (typical)
B_{OP}= ±70Gauss, B_{RP}= ±40Gauss
- Small Solution Size
- RoHS Compliant
- SIP-3L and SOT23-3L Packages
- -40°C to +150 °C Temperature Range

● Applications

- Docking Detection
- Door Open and Close Detection
- Valve Positioning
- Pulse Counting
- Electric Tools
- Rotor Position Sensing and Flow Meters
- Valve and Solenoid Status
- Proximity Sensing
- Tachometers
- Magnetic Encoder

■ Ordering Information

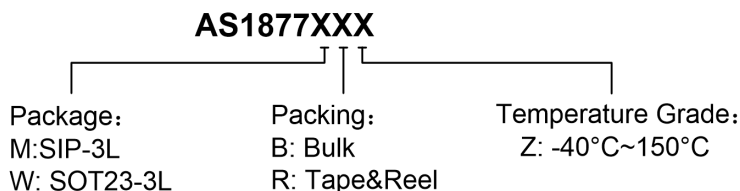

Part Number	B _{OP} /B _{RP} (Gauss)	Package Type	Package Qty	Temperature	Eco Plan
AS1877MBZ	±70/±40	SIP-3L	1K/Package	-40~150°C	RoHS
AS1877WRZ	±70/±40	SOT23-3L	7-in reel 3000pcs/reel	-40~150°C	RoHS

■ **Marking Information**

SIP-3L

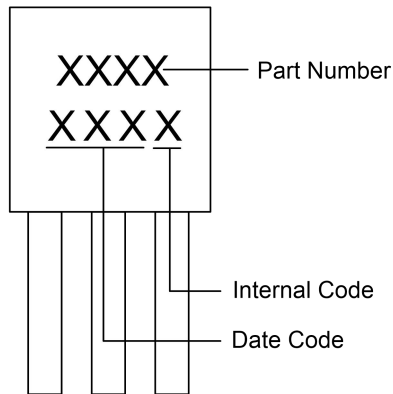

SOT23-3L

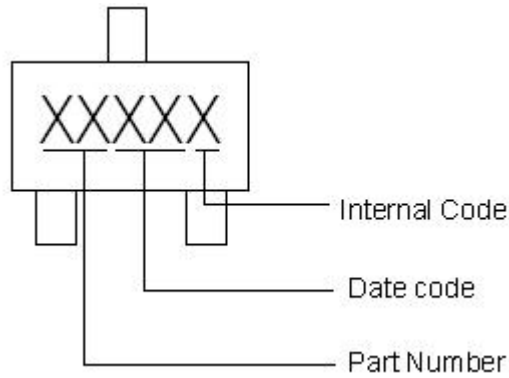

■ **Typical Application Circuit**

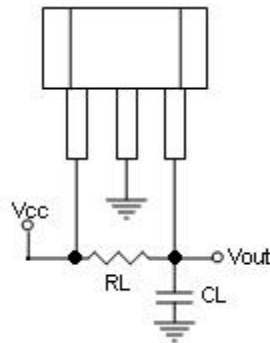
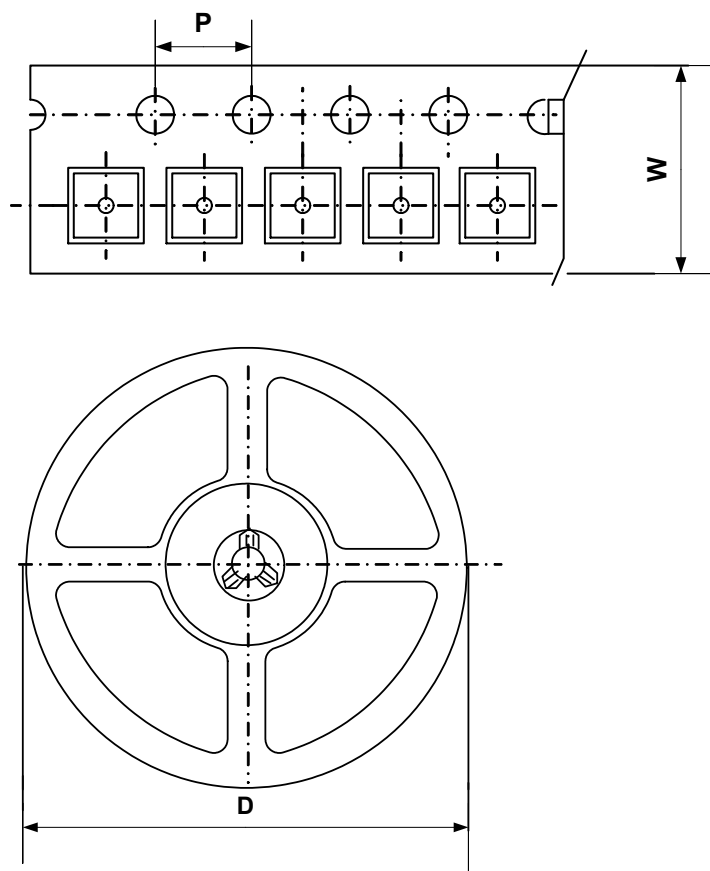

Figure 1, Typical Application Circuit of AS1877

■ **Packing Information**

SOT23-3L



Package Type	Carrier Width (W)	Pitch (P)	Reel Size(D)	Packing Minimum
SOT23-3L	8.0±0.1 mm	4.0±0.1 mm	180±1 mm	3000pcs

Note: Carrier Tape Dimension, Reel Size and Packing Minimum

■ **Packing Information**

1. Packing type: Bulk
2. Packing minimum: 1000pcs